

# One Trike Plus One Bike Rack v6.1

## Parts List

Item	Tk1Rg1 v6.0 Qty	Item	Tk1Rg1 v6.0 Qty
Baggie 6 x 6, 4ml	1	Tilt-Up – 2" square black tube 34" long	1
Box Tk1Rg1 v6.0	1	Tilt Sides – Black 5" x 6 5/8" with 5 holes	2
Hex Head Armor 1/2"-13 x 1	4	Tilt Insert - 1.25" or 2" square black tube 16.5" long	1
Hex Head Armor 1/2"-13 x 3 1/4"	4	Trike Strut – 1.25" square black tube 36" long for Tadpole or 47" long for Delta	1
Lock Washer 1/2" Yellow Zinc	4	Bike Vertical Bottom – 1 7/8" silver square channel 24" long	1
Channel Nut 1/2 Thread 3/8 thk	4	Bike Vertical Top– 1 5/8" silver square channel 24" long	1
Flat Washer 1/2" Armor Coat	4	Seat Post Hold Down – 1" x 1 5/8" silver channel 18" long	1
Nut 1/2"-13 Zinc Self-Lock	4	Black channel 1' x 1 5/8", 24" long for non-heavy duty or black channel 1 5/8" x 1 5/8", 24" long for Heavy Duty	2
Flat Washer 9/16" Armor Coat	1	Black channel 1' x 1 5/8", 36" long for non-heavy duty or black channel 1 5/8" x 1 5/8", 36" long for Heavy Duty	3
Nut 9/16"-12 Zinc Self-Lock	1	Corner Brackets – Silver L shaped	6
Hex Head Zinc 9/16"-12 X 3 1/4"	1	Cam Buckle Strap 18"	8
Flg Head Grade 8 3/8-16 x 3	5	U-Clamp 1" high for Non-Heavy Duty Rack	3
		<b>or</b>	1
		U-Clamp 1" high for Heavy Duty Rack	2
		U-Clamp 1 5/8" high for Heavy Duty Rack	
Flg Head Grade 8 3/8-16 x 1	18	Clevis Pin 9/16"	1
Flg Head Grade 8 3/8-16 x 2	5	Hair Pin for Clevis Pin	1
Clevis Pin 3/8-16 x 3	1	7" J-Bolt Assembly	1
Flat Washer 3/8 Armor Coat	9	L-Bracket	2
Lock Washer 3/8 Yellow Zinc	19	Rubber Pad	5
Nut 3/8-16 SS Self-Lock	9	Flat Bracket	2
Channel Nut 3/8 Thread, 3/8 thk	19		
Square Washer	1		
Square Nut	1		

# **CycleSimplex Bike Rack Assembly Instructions**

## **One Trike Plus One Bike Rack V6.1**

## **Precautionary and Maintenance Information:**

All straps must be used at all times.

When you are not carrying trike(s)/bike(s), you can either leave the straps attached through the slots or remove them. If you leave the straps on the rack, they should be connected just as they would with the trike or bike on the rack, otherwise they may be lost.

There is always some flex in metal. Because of this you should check and tighten bolts before each use.

You should check the straps for wear before each use and replace if they show any wear.

This trike or bike rack will extend quite a distance behind your vehicle. Caution must be used not to “bottom out” on sharp dips or rises in your path. Your rack or trike(s)/bike(s) may also extend beyond the sides of your vehicle so caution is required not to hit the rack or your trike(s)/bike(s) on other objects.

## **Liability Information**

CycleSimplex, LLC’s liability from all causes is limited to the purchase price of the trike or bike rack.

## **Warranty Information**

This trike or bike rack may be returned unused for any reason by the purchaser to CycleSimplex, LLC within 15 days of its receipt by the purchaser. For full refund, returns must be packaged so that no damage occurs to the rack in shipment and the trike or bike rack is received by CycleSimplex in like new condition...

CycleSimplex, LLC warrants the trike or bike rack from defects in material or workmanship for 90 days from the date the purchaser receives the product. During that 90 day period, CycleSimplex, LLC will at its sole discretion either replace defective components or refund the full purchase price of the trike or bike rack upon return of the trike or bike rack in like new condition.

## Material List One Trike Plus One Bike Rack v6.1

Task	Carriage/Hex Head Bolts	Flange Head Bolts	Round Silver Washer	Lock Washer	Nylon Washer	Self Lock Nuts	Channel Nuts	Square Washer	Square Nut
Attach (2) Wheel Extensions to the Bike Strut		4 – 3/8" x 1"		4			4		
Attach Corner Brackets to Trike and Bike Wheel Extensions		12 – 3/8" x 1"		12			12		
Attach Bike Vertical Top inside Bike Vertical Bottom		1 – 3/8" x 1"		1			1	1	
Attach Bike Seat Post Holder to Bike Vertical Top		1 – 3/8" x 1"		1			1		
Attach Seat Post Flat Brackets to Seat Post Holder		1 – 3/8" x 2"		1			1		
Attach Wheel Extension to Trike Strut Square Tube		2 – 3/8" x 2"	2			2			
Attach 36" Crossbar to Trike Strut-Square Tube using the U-Clamp		2 – 3/8" x 2"	2			2			
Attach Tilt Mechanism Sides to Tilt Up	1 – 3/8" x 3" Clevis Pin	1 – 3/8" x 3"	1			1			
Attach Tilt Mechanism Sides to Tilt Insert		2 – 3/8" x 3"	2			2			
Attach Trike Strut to Tilt-Up using U-Clamp		2 – 3/8" x 3" Hex Head	2			2			1
J-Bolt	7" J-Bolt Assembly								
<b>3/8" Totals</b>			<b>9</b>	<b>19</b>		<b>9</b>	<b>19</b>	<b>1</b>	<b>1</b>

Task	Carriage Head Bolts/Pins	Flange/Hex Head Bolts	Round Silver Washer	Lock Washer	Nylon Washer	Self Lock Nuts	Channel Nuts	Square Nut
Attach (2) Corner Brackets to Tilt-Up for the Bike Vertical Bottom		2 – ½" x 3 ¼" Hex Head	2			2		
Attach 36" Bike Strut with U-Clamp to Tilt-Up		2 – ½" x 3 ¼" Hex Head 1 – ½" x 1" Hex Head	2	1		2	1	
Attach (2) L-Brackets to Trike Crossbar		2 – ½" x 1"		2			2	
Attach Tilt Sides to Tilt-Up								
Attach 36" Crossbar to Trike Strut-Square Tube using the U-Clamp		1 - ½" x 1"		1			1	
<b>½" Totals</b>			<b>4</b>	<b>4</b>		<b>4</b>	<b>4</b>	
	1 – 9/16" x 3 ¾" Clevis Pin with Hair Pin	1 - Hair Pin for Clevis Pin						
Attach Bike Vertical Bottom to Corner Brackets		1 – 9/16" x 3 ¾" Hex Head Bolt	1			1		
<b>9/16" Totals</b>			<b>1</b>			<b>1</b>		

Tilt Up (2" x 2" x 34")	1	Cam Buckel Straps	8
Tilt Mechanism Sides	2	Pads	5
Trike Strut – Square Tube Delta is 1.25" x 1.25" x 47" <b>or</b> Tadpole is 1.25" x 1.25" x 36")	1	U-Clamp 1" Non-Heavy Duty Rack <b>or</b> U-Clamp 1" for Heavy Duty Rack U-Clamp 1 5/8" for Heavy Duty Rack	3 1 2
Trike Wheel Extension (36" Slotted)	1	Clevis Pin	1
Tilt Insert (1.25" or 2" inches square by 16 1/2 inches long) depending on whether you bought a 1.25" or a 2" rack	1	Hair Pin for Clevis Pin	1
Shims (2" x 5" with 2 holes) – <b>Only used with 1.25" rack</b>	2	Trike Crossbar (36" slotted)	1
Flat Brackets	2	Bike Strut (36" slotted)	1
7" J-Bolt Assembly	1	Bike Wheel Extensions (24" Slotted)	2
Corner Brackets	8	Seat Post Holder (18" silver Slotted)	1

# One Trike Plus One Bike Rack v6.1



Trike Strut – Square Tube (The Delta Is 47” Long and the Tadpole Is 36” Long)



Trike Crossbar, Trike Extension and Bike Strut are 36” long, 2 Bike Wheel Extensions are 24” long



Tilt Up for One Trike and One Bike rack



L-Bracket



Tilt Mechanism Sides

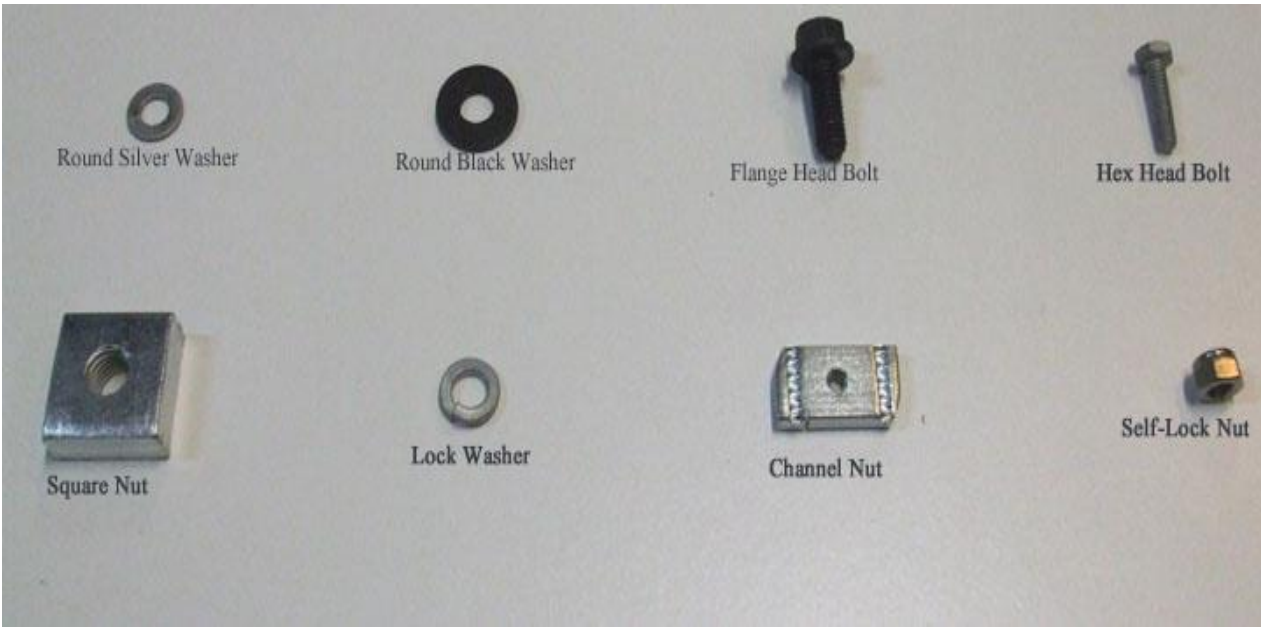


Tilt Insert



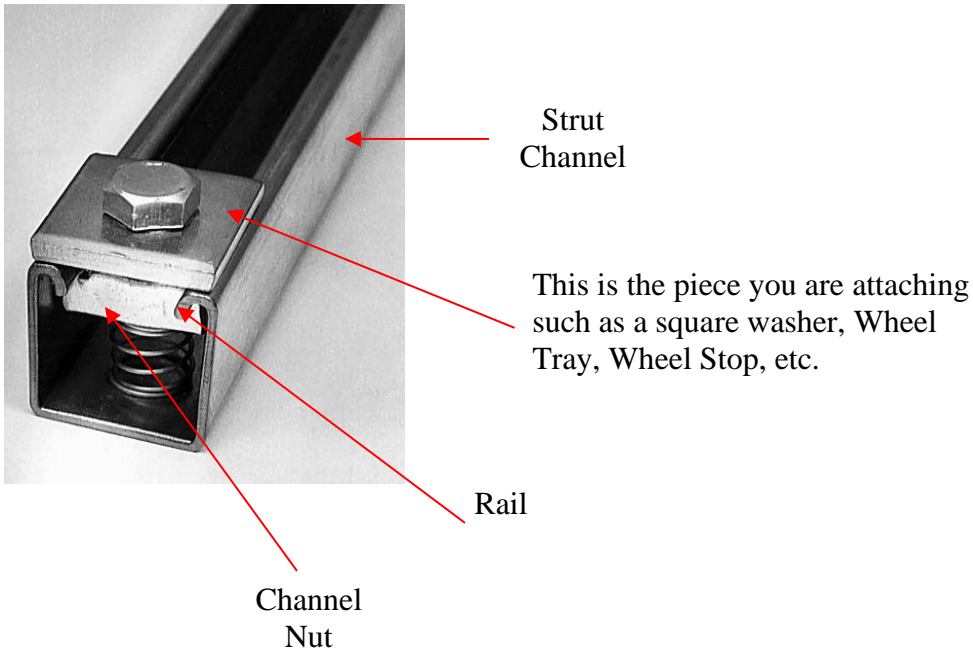
Corner Bracket

**You may not have all of these**

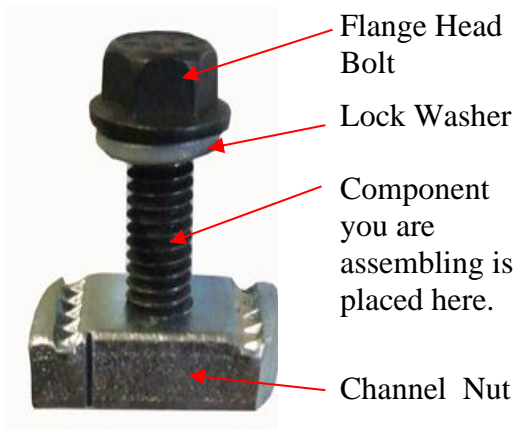


**Figure 1:** The strut channel comes in various sizes. When we describe something as strut channel, it will look like the following with 3” long slots in the bottom:

When attaching components to strut channel, it is critical that all Channel Nut Assemblies must be tightened with the channel nut under the rail as shown below. The grooves in the channel nut must be up and under the rail of the strut channel. Your channel nut will not have a spring under it.



**Figure 2:** All Bolts requiring a Channel nut must be assembled in the following fashion. This is a Bolt and Channel Assembly. This does not come as an assembled part. You have to assemble each as required in the instructions.





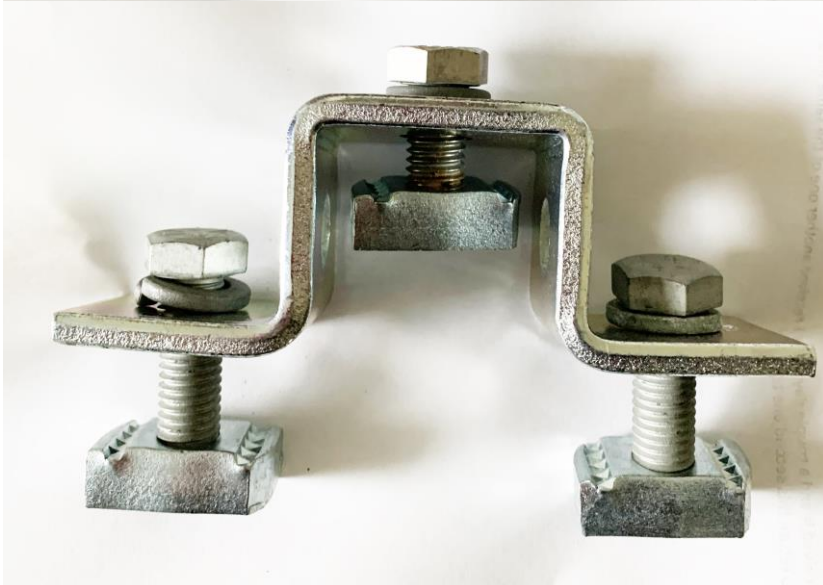
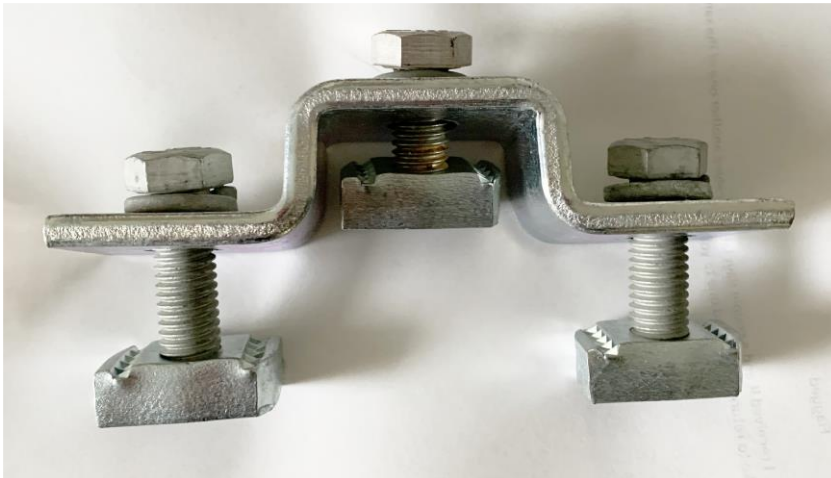
**Step 1A (This step is only for illustration purpose. You do not do this assembly until later in the instructions)** – If you have a Non-Heavy Duty Rack Create (3) U-Clamp Assemblies that are 1” deep to hold the following:

- (1) Trike Crossbar to the end of the Trike Strut
- (2) Bike Strut to the Tilt-Up
- (3) Trike Strut to the Tilt-Up

The U-Clamp assemblies shown below are shown with ½” hex head bolts for illustration purposes. The type bolts and sizes will be explained at the actual step further in the instructions. You will not use the center bolt in the Trike Strut to Tilt-Up assembly

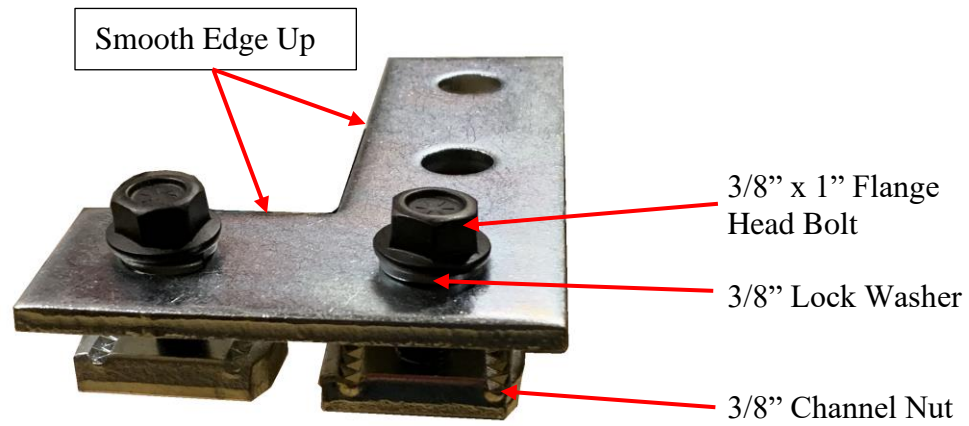
**Step 1B (This step is only for illustration purpose. You do not do this assembly until later in the instructions)** – If you have a Heavy Duty Rack Create (1) of the U-Clamps that is 1” deep and (2) that are 1 5/8” deep to hold the Trike Strut to the Tilt-Up and (2) U-Clamp Assemblies from below to hold the Trike Crossbar to the end of the Trike Strut and to hold the Bike Strut to the Tilt-Up.

**The actual bolts used later in the instructions may be black or silver, according to the specific instructions.**



## Step 2: Create 6 Corner Bracket Assemblies

**IT IS IMPORTANT THAT THE SMOOTH EDGE OF THE CORNER BRACKET IS UP SO AS NOT TO WEAR THE TIRE**



**Step 3: Assemble Tilt Mechanism Sides, Tilt Up and Tilt Insert as shown in the picture below**

**If you have a 1.25" rack, do Step 3A. If you have a 2" rack, you will not use the Shims.**

### **Step 3A**

Place the two Shims on each side of the Tilt Insert so that they are over the two holes in the Tilt Insert. Pass the two 3/8" x 3" black Flange Head bolts through the two holes C and D in the bottom of the Tilt Sides, then the Shim, the Tilt Insert, the other Shim and the other Tilt Side (the shorter distance from Hole B to Hole C should be toward the bottom of the Tilt Sides). Place a 3/8" round silver washer and 3/8" self-locking nut on the end of the two bolts. Finger tighten. Do not tighten all the way yet.

Pass a 3/8" x 3" black flange head bolt through the Tilt Sides and the Tilt Up in Hole A. Place a 3/8" round silver washer and 3/8" self-locking nut on the end of this bolt. Finger tighten the nut

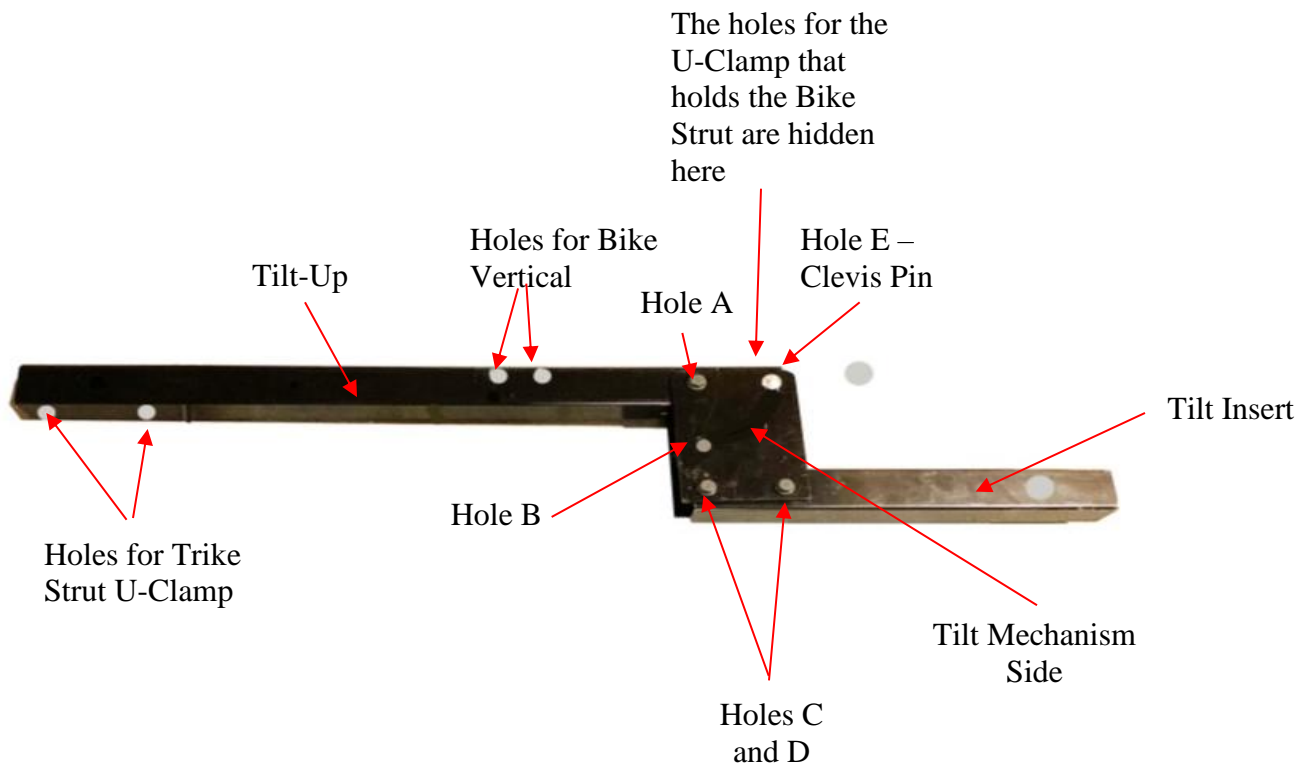
Pass the Clevis Pin through Hole E. Insert the Hair Pin into the hole in the end of the Clevis Pin.

Tighten all nuts

If you want to tilt the rack up, remove the Clevis Pin from Hole C, tilt the Tilt-Up up and place the Clevis Pin in Hole B.

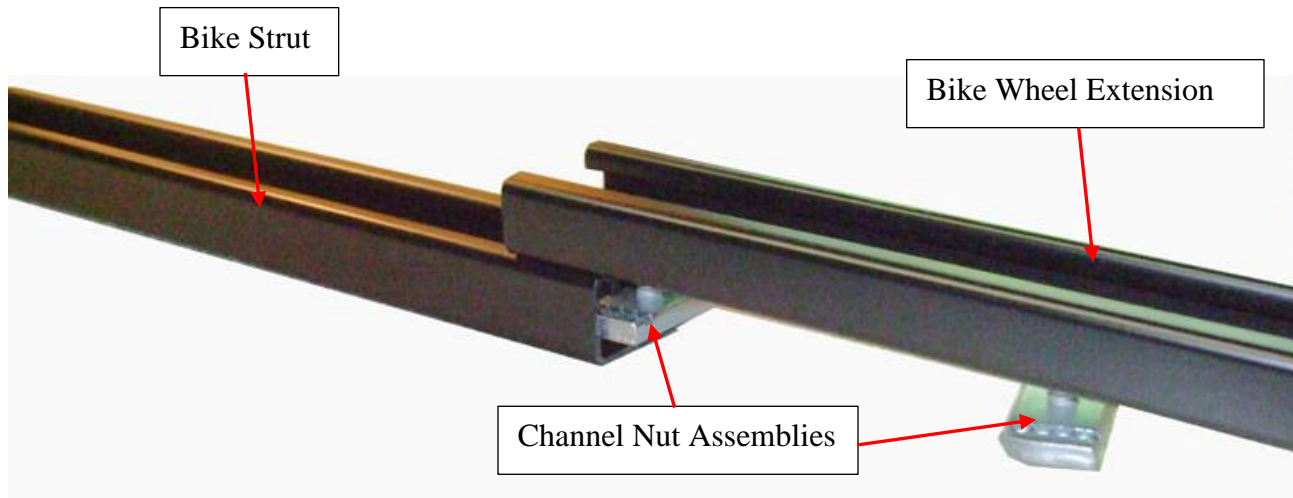
### **Step 3B**

If you have a 2" rack you will do all the steps in Step 3A except you will not have the 2 Shims

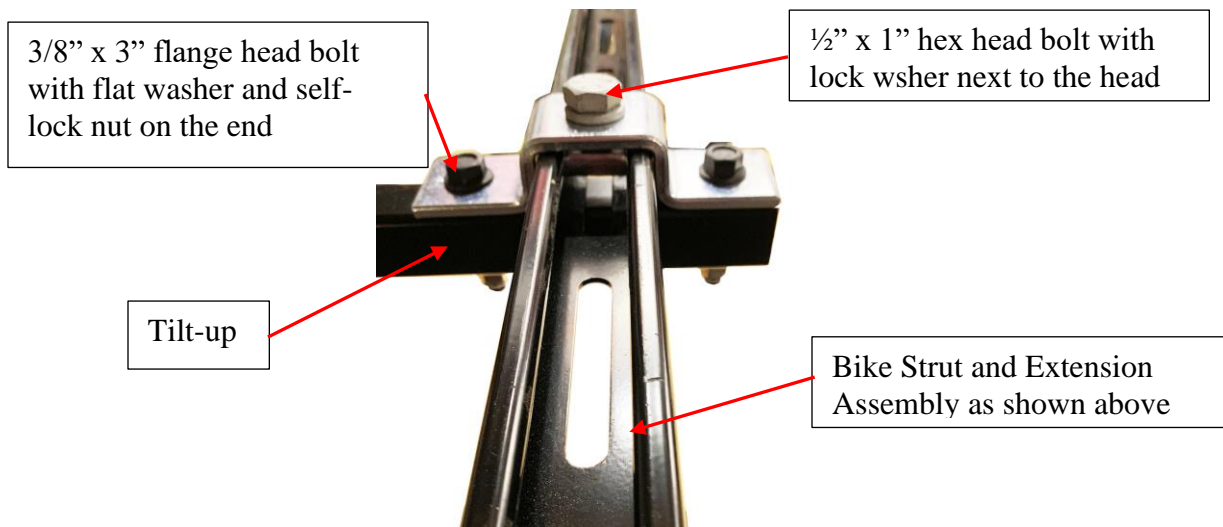


**Step 4: Assemble the Bike Strut and Extensions and attach to the Tit-up with the 1" U-Clamp**

The two Bike Wheel Extensions go on top of the Bike Strut with the Channel Nut Assemblies. Only one Wheel Extension is shown in the picture below. The other one goes on the other end of the Bike Strut. Place a 3/8" lock washer under the head of a 3/8" x 1" flange head bolt. Pass the bolt through adjacent slots in the Trike Crossbar and place a 3/8" channel nut on the end. Make certain the channel nuts are under the rails of the Bike Strut. Adjust the length of the Bike Strut Assembly to be the wheelbase (axle to axle) of the bike plus 11" and tighten the bolts. This length may have to be adjusted when you actually set you bike on the rack.



The Bike Strut and Wheel Extensions are attached to the Tilt-up as shown below.



**Step 5 –Assemble the Trike Strut – Square Tube and Wheel Extension Assembly as shown below:**

**5A: If you have a delta trike, use this Step 5A.** Lay the Wheel Extension and the Trike Strut - Square Tube as shown below so that the total length of the two components is your delta trike’s wheelbase plus 10 inches

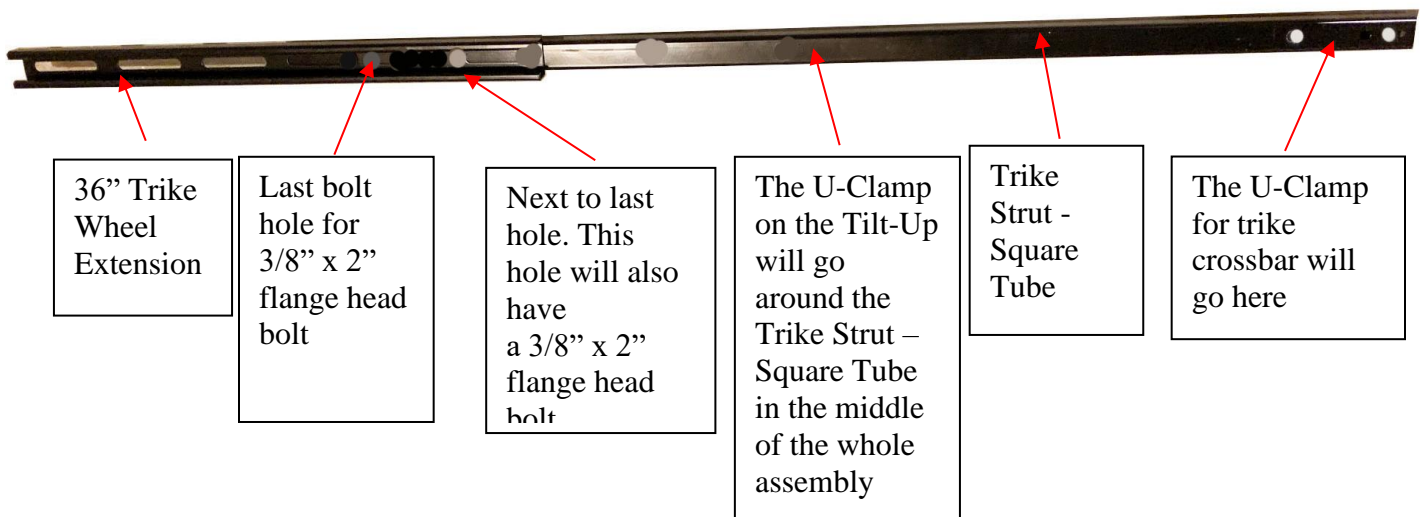
**5B: If you have a tadpole trike, use this Step 5B.** Lay the Wheel Extension and the Trike Strut - Square Tube as shown below so that the total length of the two components is the distance from the back edge of the rear wheel to the axel of the front wheels plus 2”.

**For either type trike do the following:** Fasten the 36” long Wheel Extension on top of the Trike Strut – Square Tube. Using the last two holes to the left end of the Trike Strut – Square Tube. Pass a 3/8” x 2” flange head bolt through the Wheel Extension and the last hole to the left in the Trike Strut – Square Tube. Place a flat washer and then a self-lock nut on the bolt and finger tighten.

Do this again for the next to last hole to the left of the Trike Strut – Square Tube and the Wheel Extension. This will be depicted in below.

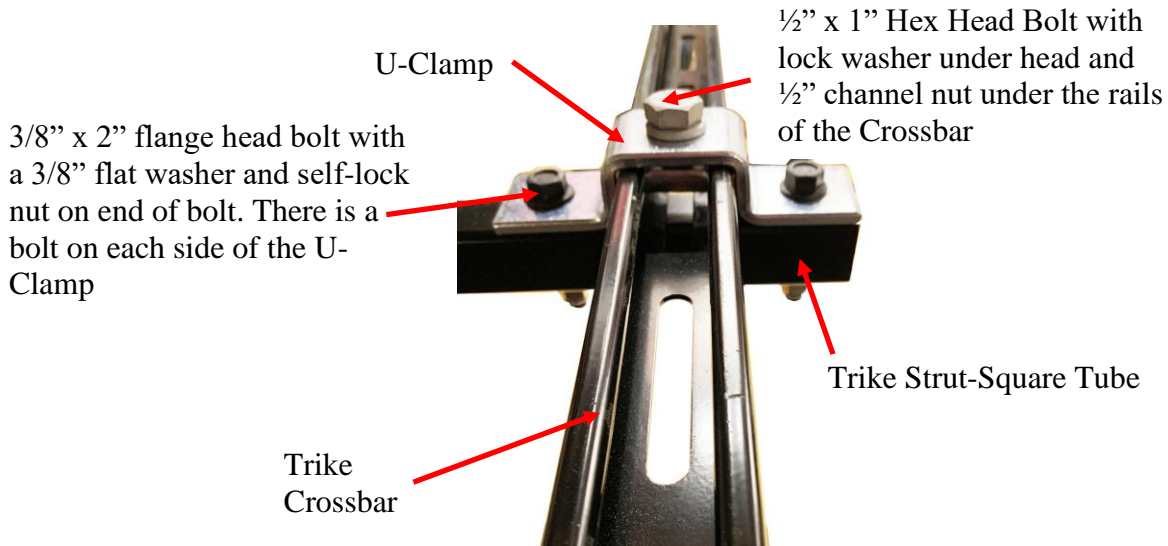
Tighten all nuts

This Assembly will be attached to the Tilt-Up with a U-Clamp later



**Step 6 – Assemble the Trike Crossbar to the Trike Strut – Square Tube. The Trike Crossbar U-Clamp and Trike Crossbar will be placed on the right end of the Trike Strut – Square Tube indicated above**

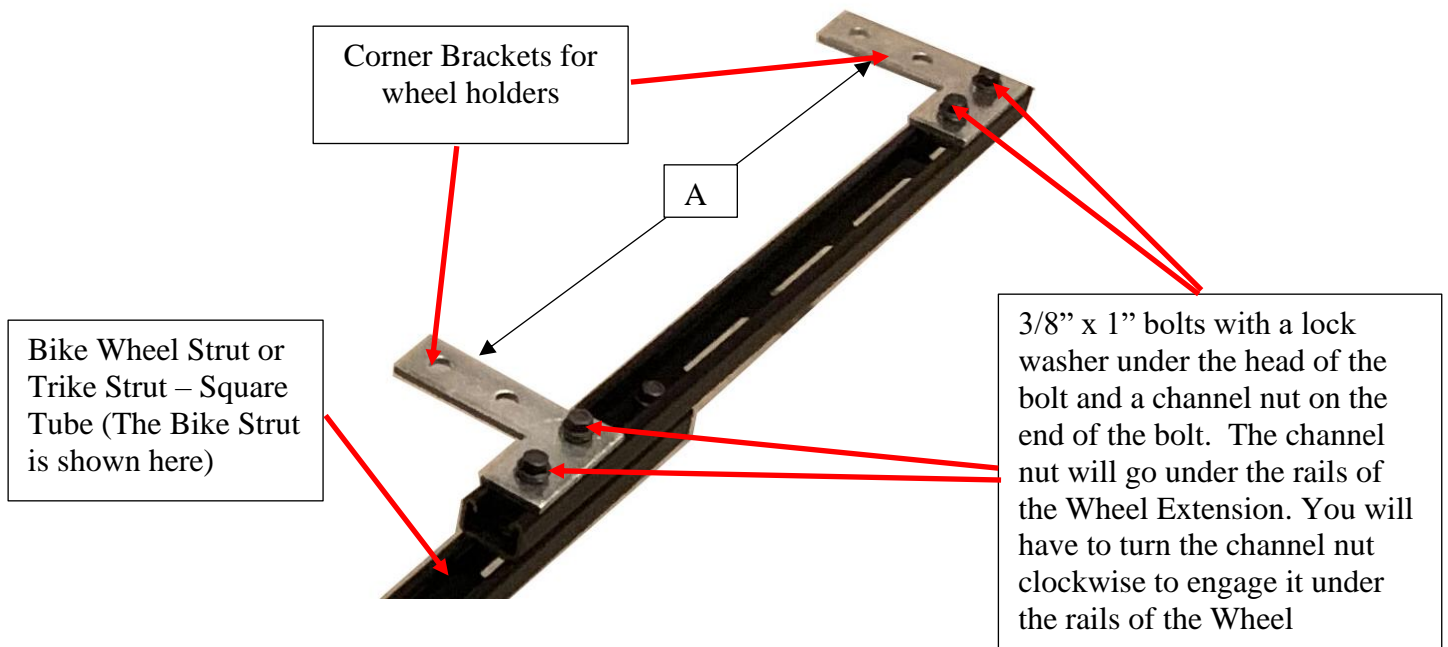
The U-Clamp (Step1) will attach the Crossbar to the Trike Strut as shown below.



**Step 7** – Attach the Corner Brackets to the Bike Wheel Extensions that are attached to the Bike Strut and the Trike Wheel Extension that is attached to the Trike Strut – Square Tube. These Corner Brackets will hold your wheels in place

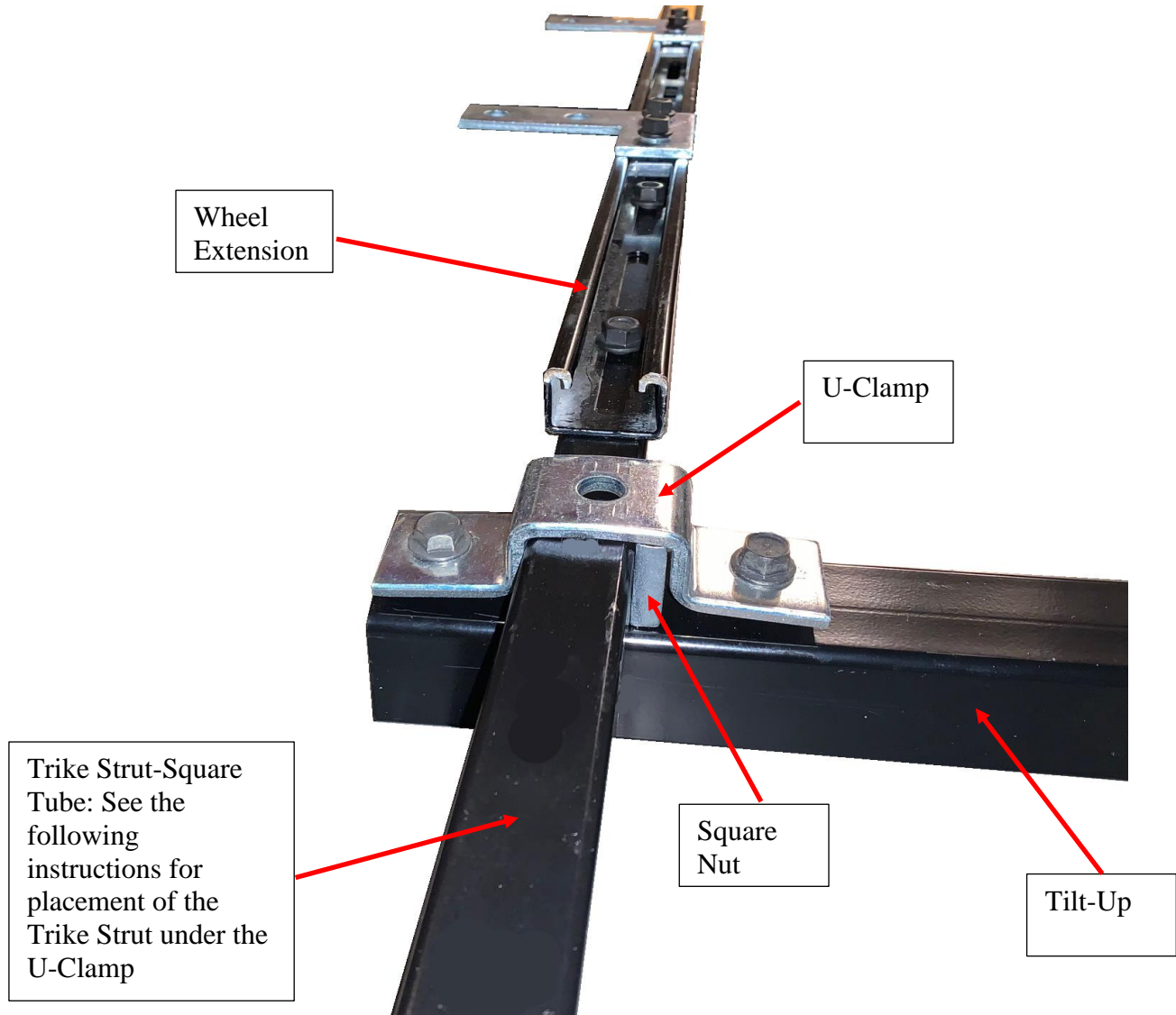
The distance for ‘A’ in the picture below will depend on your wheel diameter. The chart of wheel diameters and the distance of A are as follows:

'A' Distance	Diameter of Wheel
12 ½"	16" Diameter Wheel
14 ¼"	20" Diameter Wheel
16 ½"	26" Diameter wheel
17 ½"	29" Diameter Wheel



**Step 8: Attach the Trike Strut - Square Tube and Wheel Extension Assembly made in Step 5 to the Tilt-Up using the U-Clamp.**

As shown below you are going to place the U-Clamp over the Trike Strut – Square Tube and attach the U-Clamp to the Tilt-Up using the two ½” x 3 ¼” hex head bolts in Step 1. The U-Clamp will not be snug against the Trike Strut- Square Tube so you will have to put a Square Nut inside the U-Clamp as shown below. Gradually tighten each 3/8” bolt evenly so that the U-Clamp holds the Trike Strut – Square Tube and the Square Nut tightly. It is OK to bend each arm of the U-Clamp a little as you tighten the bolts.



**If you Have a delta rack, use Step A1 below:**

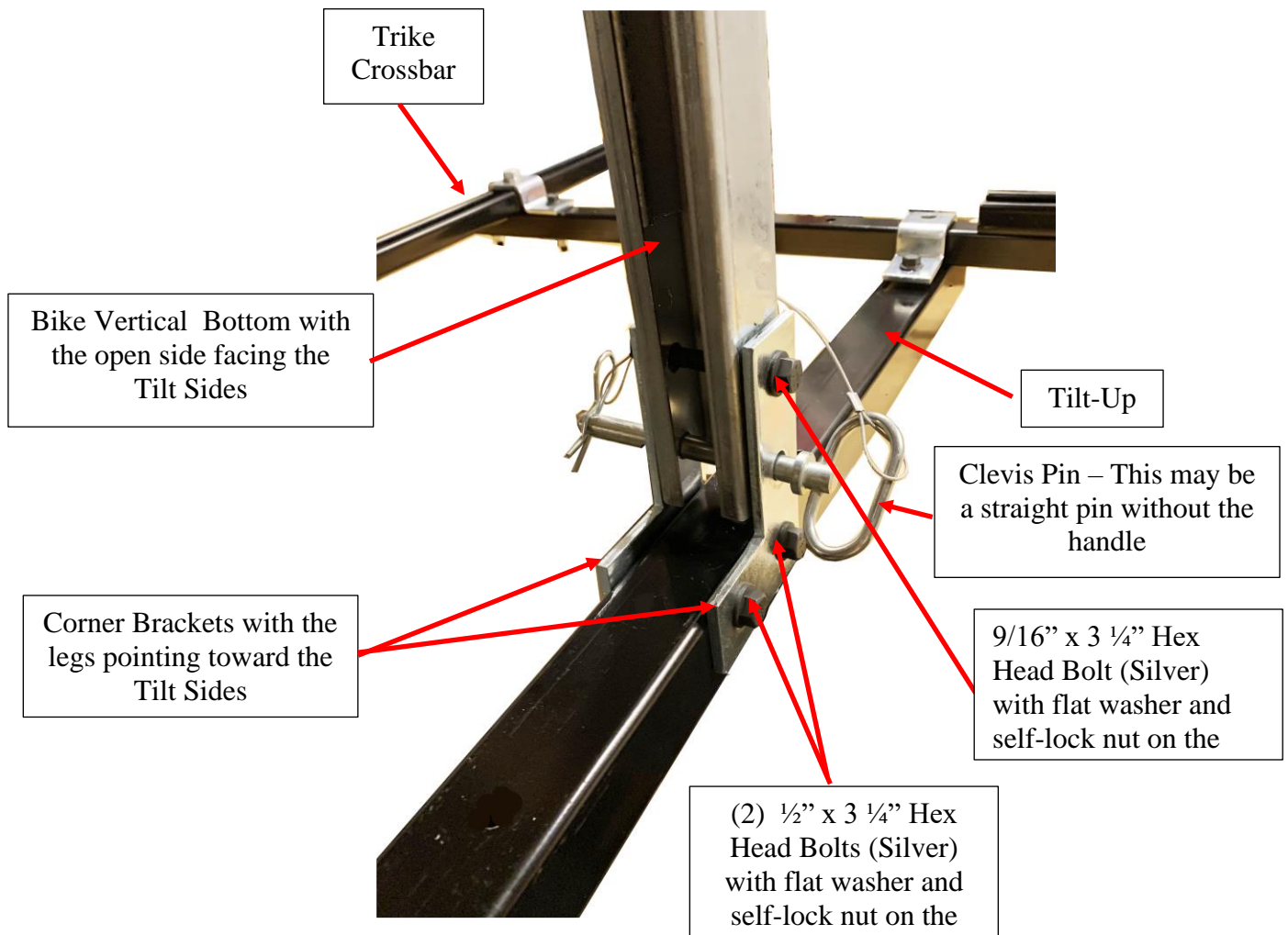
**A1:** Align the Trike Strut – Square Tube and Wheel Extension Assembly within the U-Clamp and over the Tilt-Up so that the Assembly is 5” longer on the side with the Trike Wheel Extension

**If you have a tadpole rack, use Step A2 above:**

**A2:** Measure the distance from the back edge of your rear tire to the end of the boom by the front wheels. Divide that length by 2. This is the distance from the outside end of the Wheel Extension to the U-Clamp in the picture above. You may have to slide the Trike Strut – Square Tube within the U-Clamp later to align the trike behind the vehicle.

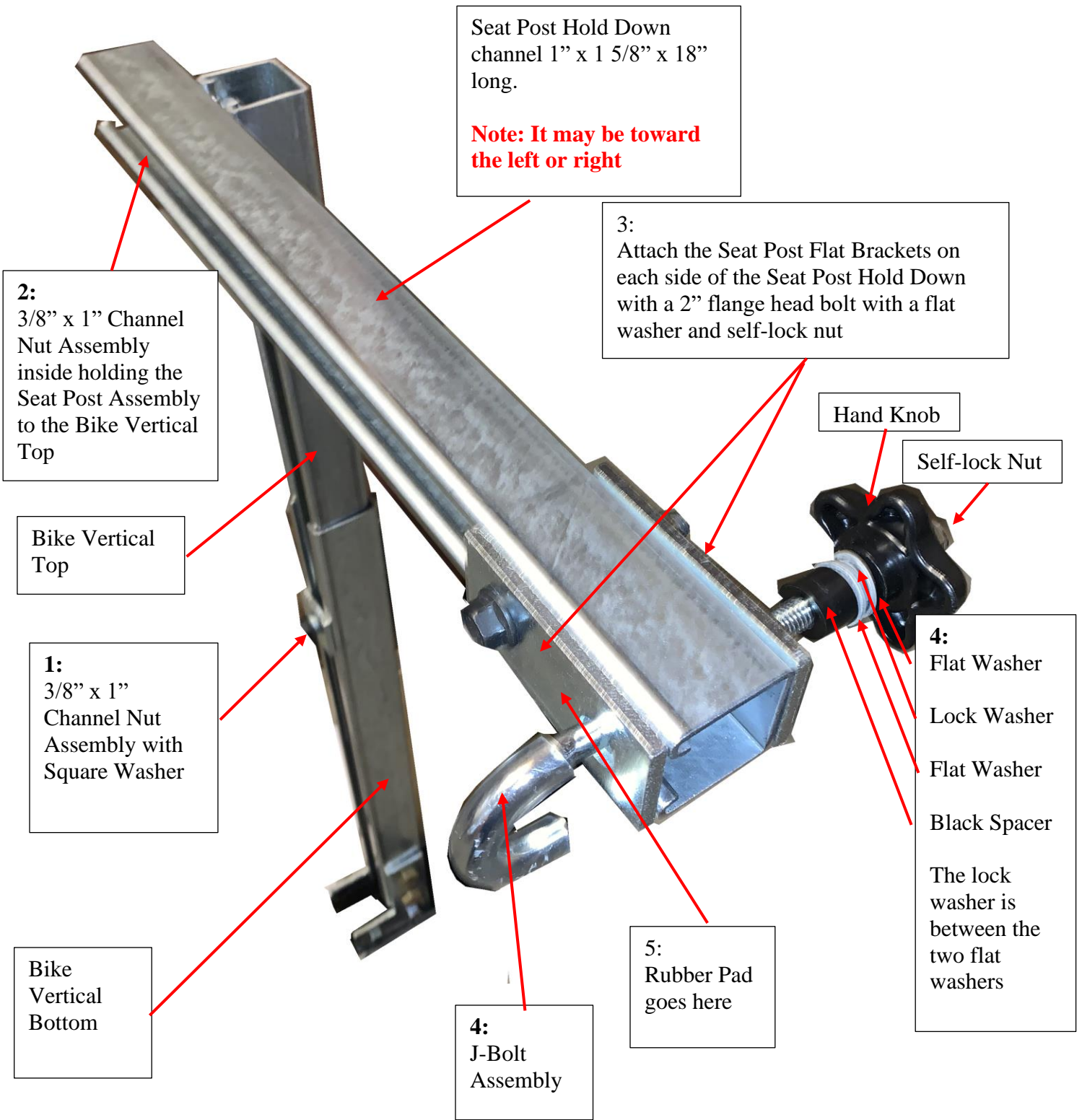


**Step 9: Attach the Bike Vertical Bottom to the Tilt-Up with 2 Corner Brackets**



**Step 10: Fasten Bike Vertical Top inside the Bike Vertical Bottom and assemble the Seat Post Assembly:**

1. Slide the Bike Vertical Top inside the Bike Vertical Bottom and secure with the 3/8" x 1" Channel Nut Assembly. The lock washer and the square washer will go under the head of the flange head bolt and the channel nut will go inside the Bike Vertical top and is turned so it is on top of the rails of the Bike Vertical Top.
2. Attach the Seat Post Hold Down to the Bike Vertical Top using a 3/8" x 1" Channel Nut Assembly. The flange head bolt should have a lock washer next to the head. Pass the bolt through the Seat Post Hold Down and attach it to the Bike Vertical Top with a channel nut. Be certain the channel nut is under the rails of the Bike Vertical Hold Down.
3. Bolt the Seat Post Flat Brackets on each side of the Seat Post Hold Down using a 3/8" x 2 3/4" flange head bolt. Pass the bolt through the left of the Seat Post Flat Brackets and place a 3/8" self-lock nut on the end of the bolt.
4. Place the J-Bolt through the right end slot in the Seat Post Hold Down and Flat Brackets. Place the black round spacer on the J-Bolt then a flat washer, then a lock washer, then another flat washer and then, the hand knob and finally the self-lock nut on the J-Bolt
5. Attach the Rubber Pad to protect the seat post



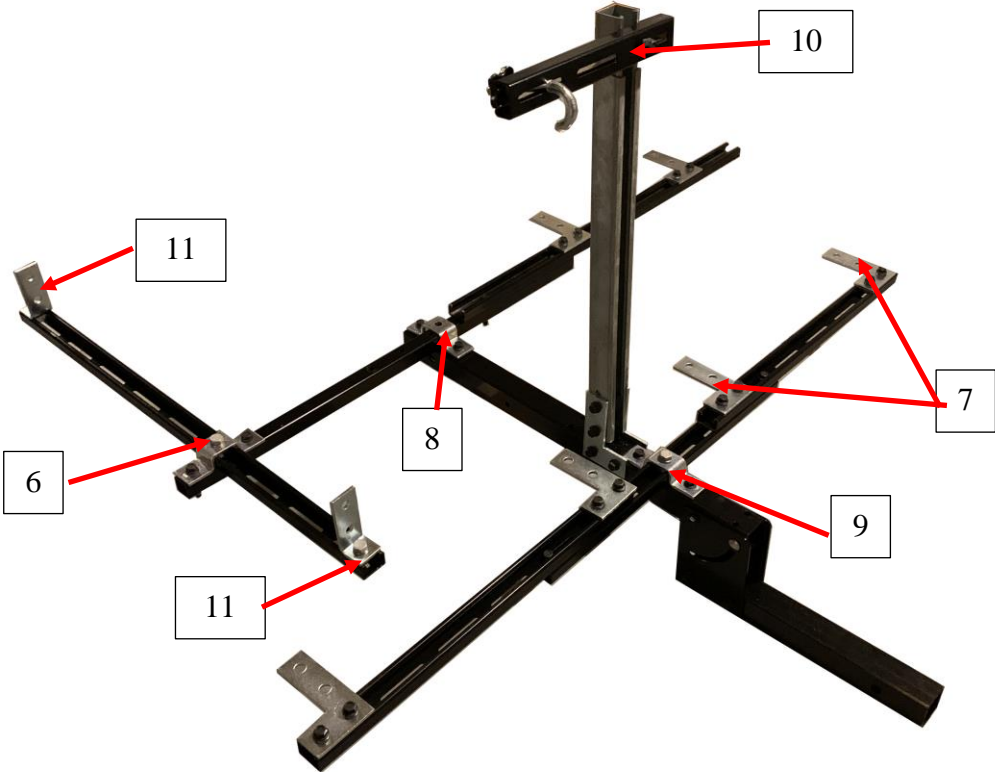
**Step 11: Attach the (2) L-Brackets to the Trike Crossbar:** Measure the distance from the outside of one tire to the outside of the other tire. This will be the distance between the L-Brackets. a ½” lock washer under the head of each ½” hex head bolt and place the bolts through each L-Bracket.

Place a channel nut on the end of the bolts. Slide the channel nuts inside the Trike Crossbar so that the channel nuts are on the rails of the Crossbar and tighten so that the L-Brackets are on the outside of each wheel.



½” hex head bolt  
with lock washer  
under the head and  
channel nut on the  
end

# Finished Rack



The straps holding the front wheels of the tadpole trike or the rear wheels of the delta trike will be like straps in the picture below.



The straps holding the wheel in the Wheel Holder of the rear wheel on a tadpole or the front wheel on a delta or both the wheels of a two wheeled bike will be as shown in the picture below.



